

Thermostatic SECURITHERM securitouch auto-drain shower kit.

Ref. H9741HYG

Securitouch dual control thermostatic mixer

DESCRIPTION

Thermostatic SECURITHERM securitouch auto-drain shower kit. - Ref. H9741HYG

SECURITHERM dual control thermostatic shower kit with auto-draining device:

- Shower mixer with scale-resistant thermostatic cartridge:
- Mixer with anti-scalding failsafe: shuts off automatically if cold water supply fails.

Prevents cold showers: shuts off automatically if hot water supply fails.

Securitouch thermal insulation prevents burns.

Scale-resistant thermostatic cartridge adjusts the temperature.

¼-turn ceramic valve head adjusts the flow rate.

Temperature control from 25 - 41°C.

Double temperature limiter: 1st limiter set at 38°C can be overridden, 2nd limiter set at 41°C.

Thermal shocks are possible without removing the control knob or shutting off the water supply.

Flow rate regulated at 9 lpm.

Chrome-plated brass body with ERGO controls.

M1/2" shower outlet.

Filters and non-return valves integrated on the inlets, F3/4".

Mixer with offset STOP/CHECK wall connectors, M1/2" M3/4".

- Shower head (ref. 813) with chrome-plated wall-mounted adjustable support (ref. 845).
- Auto-draining device FM1/2" for installation between the flexible hose and the shower head, automatically drains the shower head and flexible hose (ref. 880).

Mixer ideal for healthcare facilities, retirement and care homes, hospitals and clinics.

Mixer suitable for people with reduced mobility.

Shower mixer with 10-year warranty.

TECHNICAL CHARACTERISTICS

Thermostatic SECURITHERM securitouch auto-drain shower kit. - Ref. H9741HYG

Connector	M1/2"
Technology	SECURITHERM Securitouch thermostatic mixer
Depth	92mm
Length	286mm
Flow rate	9 lpm
Temperature limiter	Yes
Finish	Chrome-plated brass



ADVANTAGES



SECURITHERM: Optimum anti-scalding safety



Double maximum temperature limiter



Securitouch thermal insulation prevents burns



Thermostatic: total temperature stability

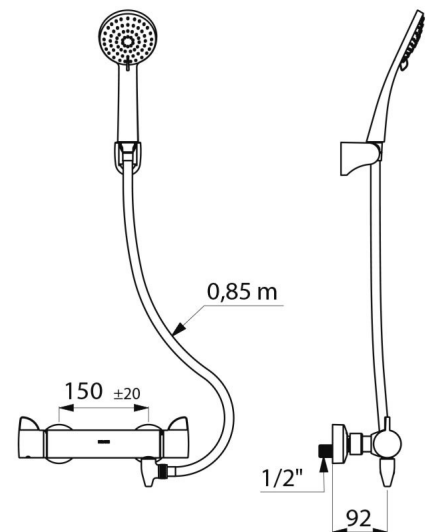

Norms



Warranty

